

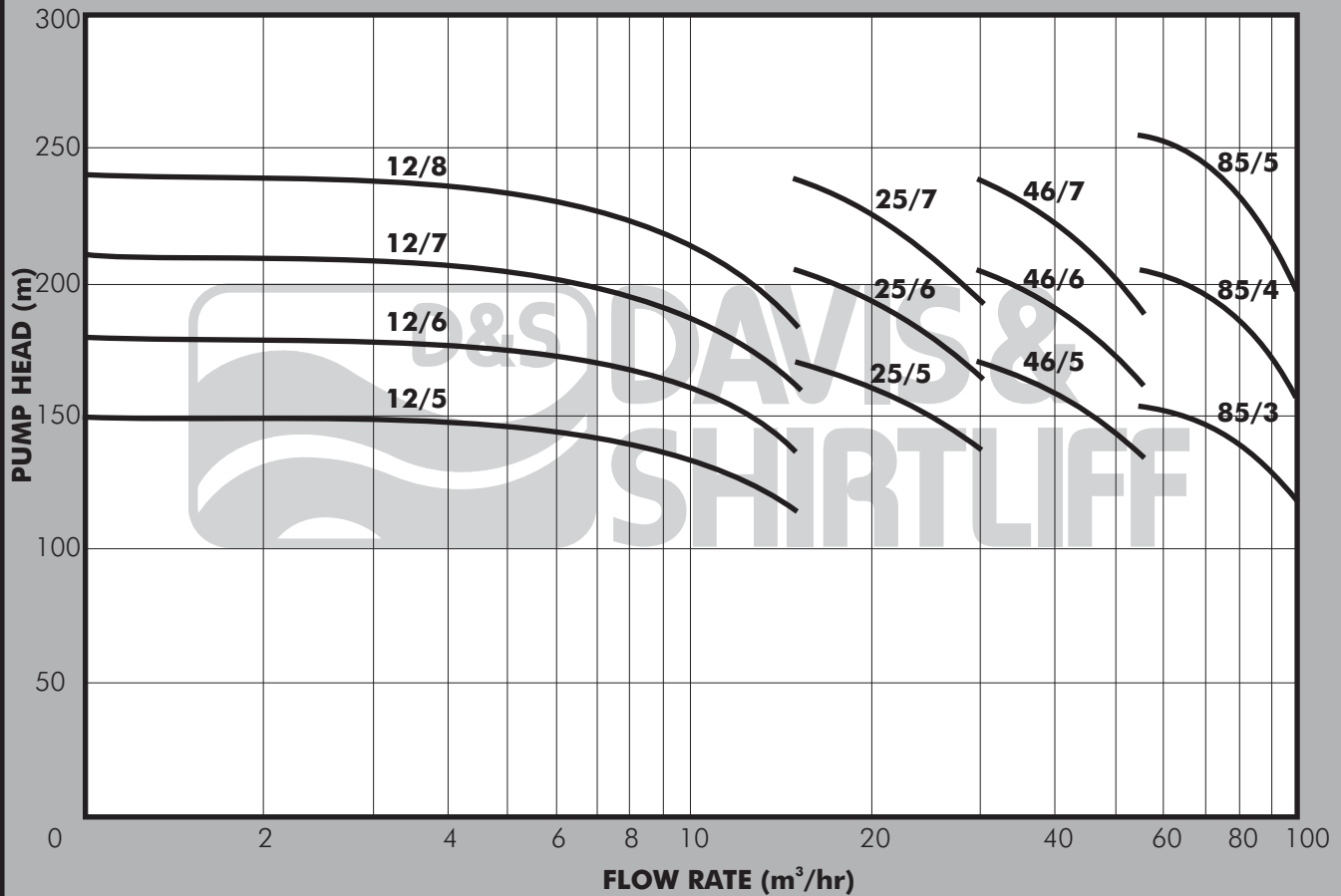

**DATA SHEET**

**Horizontal Multistage Centrifugal Pumps**

**DMS**



## PUMP

The DAYLIFF DMS range of horizontal multistage centrifugal pumps are heavy duty industrial quality pumps suitable for various water supply, irrigation and industrial applications. Particular features include gland packing seals for simple and economical maintenance and external securing tie bolts for ease of disassembly. Construction is heavy duty cast iron stages and pump body, with cast iron impellers and diffusers and stainless steel shaft.

A wide range of models and specifications are available, a combination of the pump size and number of stages being selected to achieve maximum efficiency at a specific duty point. Electric motors are selected according to the required power input at the duty point and mounted together with the pump and coupling on a base frame. All pumps are also suitable for direct or belt drive by diesel engine.

## OPERATING CONDITIONS

**Pumped liquid:** Thin, clean, chemically non-aggressive liquids without abrasive particles or fibres

**Max. Fluid Temperature:** +110°C

**Max. Suction Pressure:** 10 Bar

**Max. Delivery Pressure:** 30 Bar

**Rotation:** Clockwise viewed from driving end

## STANDARD DIMENSIONS

Pump Size	Dimensions (mm)								Shaft			Inlet Flange				Outlet Flange			
	Inlet	Outlet	L1	L4	L5	E	H1	H	d	u	g	D	A	O	Holes	D	A	O	Holes
<b>DMS 12</b>	50	40	210	265	62	170	150	170	25	8	21	50	140	110	4X13.5	40	150	110	4X17.5
<b>DMS 25</b>	65	65	295	330	80	210	170	210	30	8	26	65	160	130	4X17.5	65	185	145	8X17.5
<b>DMS 46</b>	80	65	295	330	80	210	170	210	30	8	26	80	190	150	4X17.5	65	185	145	8X17.5
<b>DMS 85</b>	100	100	345	326	86	250	210	250	35	10	30	100	210	170	4X17.5	100	235	180	8X22

## STANDARD DIMENSIONS

Stages	DMS 12				DMS 25				DMS 46				DMS 85			
	Power* (Kw)	L2	L3	Weight (kg)	Power* (Kw)	L2	L3	Weight (kg)	Power* (Kw)	L2	L3	Weight (kg)	Power* (Kw)	L2	L3	Weight (kg)
<b>3</b>	-	-	-	-	-	-	-	-	-	-	-	-	55	277	906	877
<b>4</b>	-	-	-	-	-	-	-	-	-	-	-	-	75	351	980	1040
<b>5</b>	11	210	795	292	22	360	975	452	37	360	975	560	90	425	1054	1061
<b>6</b>	15	210	845	316	30	425	1040	572	37	425	1040	576	-	-	-	-
<b>7</b>	15	210	895	333	30	490	1105	592	45	490	1105	664	-	-	-	-
<b>8</b>	18.5	210	945	370	-	555	1170	-	-	-	-	-	-	-	-	-

\* Power absorbed at 2900rpm

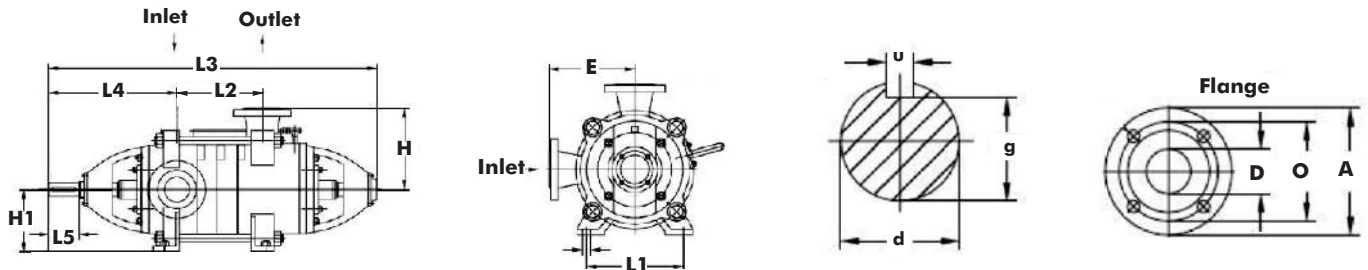

© Davis & Shirliff 2023. Contents herein are not warranted. The right is reserved to amend specifications without notice. [www.davisandshirliff.com](http://www.davisandshirliff.com)

DY201A-07/11

<b>KENYA</b> Nairobi - Head Office Tel: (254) 711 079 000 Nairobi - Westlands Tel: (254) 711 079 683/2/7/8/9 Nairobi - Downtown Tel: (254) 715 439 392 Eastleigh Tel: (254) 711 079 645 Utawala Tel: (254) 780 575 745 Nairobi - Karen Tel: (254) 726 442 342 Ongata Rongai Tel: (254 20) 240 0146 Kiambu Tel: (254) 701 646 309 Githurai Tel: (254) 758 727 332	Naivasha Tel: (254 50) 203 0510 Lodwar Tel: (254) 724 248 692 Eldoret Tel: (254) 715 590 000 Nakuru Tel: (254 20) 221 3248 Narok Tel: (254) 701 683 283 Kakamega Tel: (254 56) 203 1889 Kitale Tel: (254) 748 590 143 Bungoma Tel: (254) 740 048 514 Kisumu Tel: (254) 724 352 504 Kisii Tel: (254 58) 203 0949	Kericho Tel: (254) 780 703 197 Muranga Tel: (254) 780 377 682 Thika Tel: (254) 719 867 504 Kihengela Tel: (254) 705 155 522 Machakos Tel: (254) 712 650 283 Kitui Tel: (254) 701 683 289 Embu Tel: (254) 780 455 512 Meru Tel: (254 64) 313 1033 Nyeri Tel: (254) 799 496 253 Nanyuki Tel: (254 62) 203 0018	Garissa Tel: (254) 715 494 838 Marsabit Tel: (254) 748 590 140 Wajir Tel: (254) 780 523 728 Isiolo Tel: (254) 717 125 182 <b>KENYA - COAST</b> Mombasa - Main Office Tel: (254 41) 249 0885 Mombasa - Downtown Tel: (254) 780 567 379 Malindi Tel: (254 42) 212 0425 Diani Tel: (254 40) 320 2181 Lamu Tel: (254 20) 265 1052	Nyali Tel: (254 20) 244 3357 Voi Tel: (254 20) 202 8284 Mtwarapa Tel: (254) 798 478 113 <b>RWANDA</b> Kigali Tel: (250 252) 504 039 Rubavu Tel: (243 814) 326 631 Gakiriro Tel: (250 781) 182 374 <b>SOUTH SUDAN</b> Juba Tel: (211) 927 000 020	<b>ZAMBIA</b> Lusaka Tel: (260 211) 845 010/1 Lusaka - ChaChaCha Tel: (260 211) 842 350 Ndola Tel: (260 212) 610 936 Kitwe Tel: (260 212) 221 747 Livingstone Tel: (260 213) 320 002 Solwezi Tel: (260 218) 821 822 Chipata Tel: (260 216) 222 636 <b>DRC</b> Lubumbashi Tel: (243) 978 115 412	<b>UGANDA</b> Kampala - Main Office Tel: (256) 783 065 273 Kampala - Kitgum House Tel: (260 211) 842 350 Kampala - Nakasero Tel: (260 212) 610 936 Kitwe Tel: (256 392) 734 633 Kampala - Shauri Yako Tel: (256 414) 660 770 Gulu Tel: (256 471) 433 041 Mbarara Tel: (256 392) 001 556 <b>ZIMBABWE</b> Harare Tel: (263) 24 257 6246	<b>TANZANIA</b> Dar es Salaam - Main Office Tel: (255 22) 211 2515 Dar es Salaam - Kariakoo Tel: (255 22) 218 4867 Arusha Tel: (255 27) 254 7317 Zanzibar Tel: (255) 774 202 069 Mwanza Tel: (255) 783 451 540 Dodoma Tel: (255) 753 506 530 <b>ETHIOPIA (Associate)</b> Addis Ababa Tel: (251 11) 668 7925/29
--	--	---	---	---	--	--	---



[www.davisandshirliff.com](http://www.davisandshirliff.com)



Davis & Shirliff



@dayliff



# DMS 12 PUMP CURVES 2950RPM

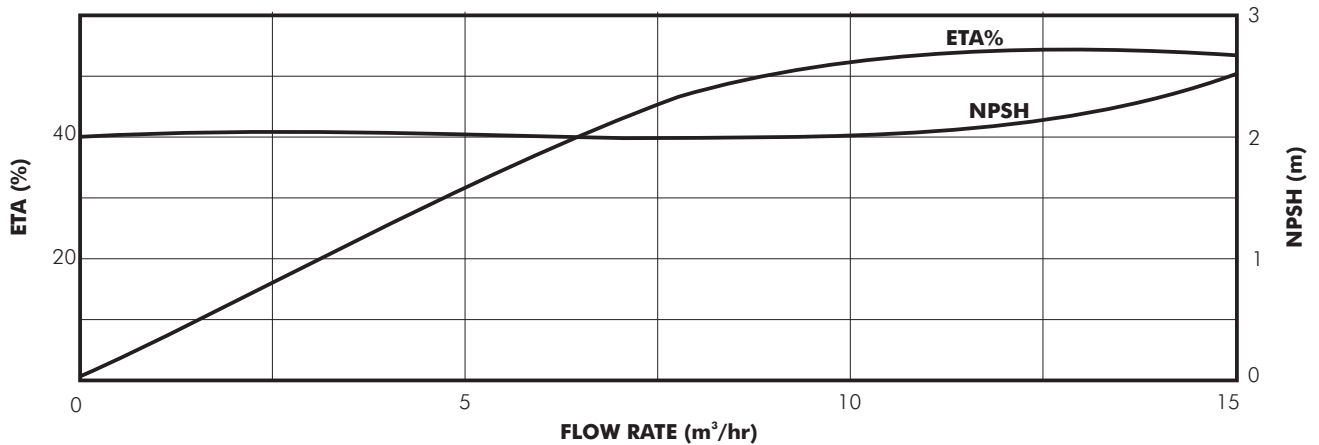
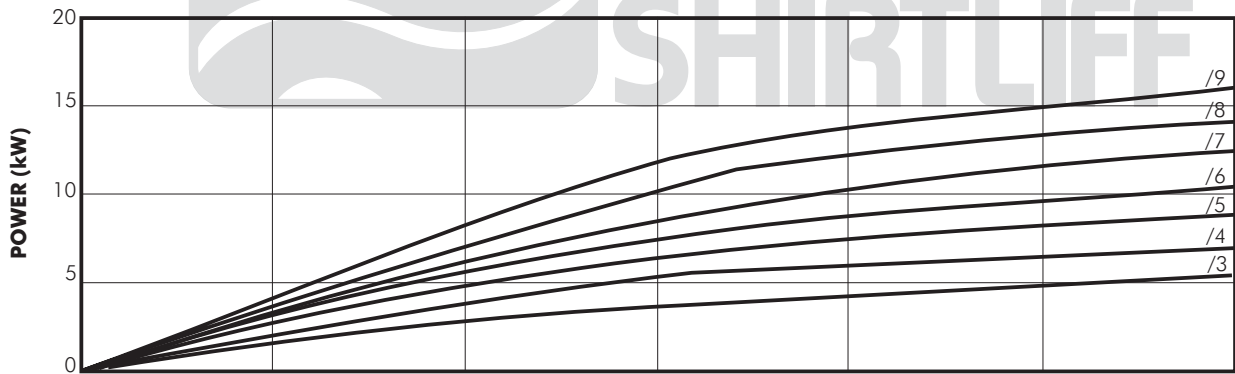
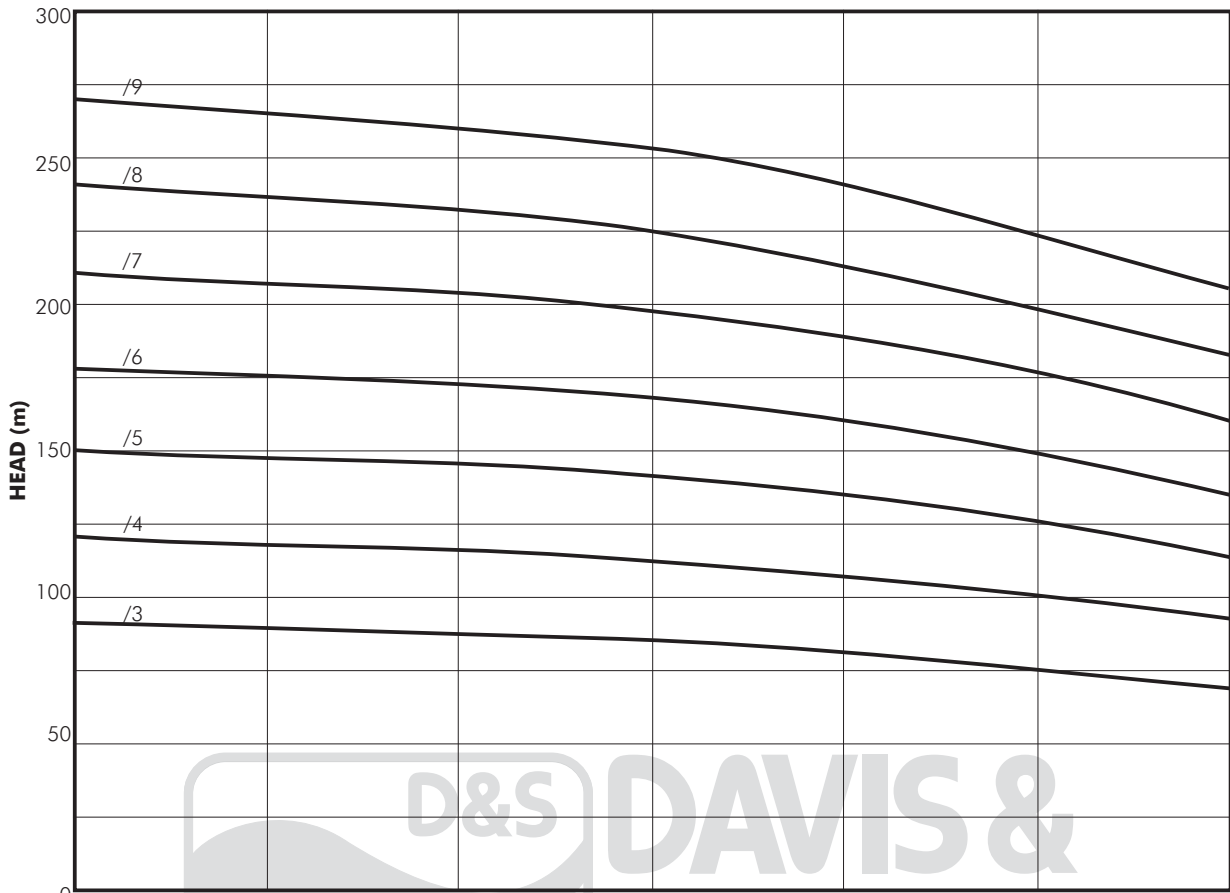

# DAYLIFF

## DMS 25 PUMP CURVES 2950RPM

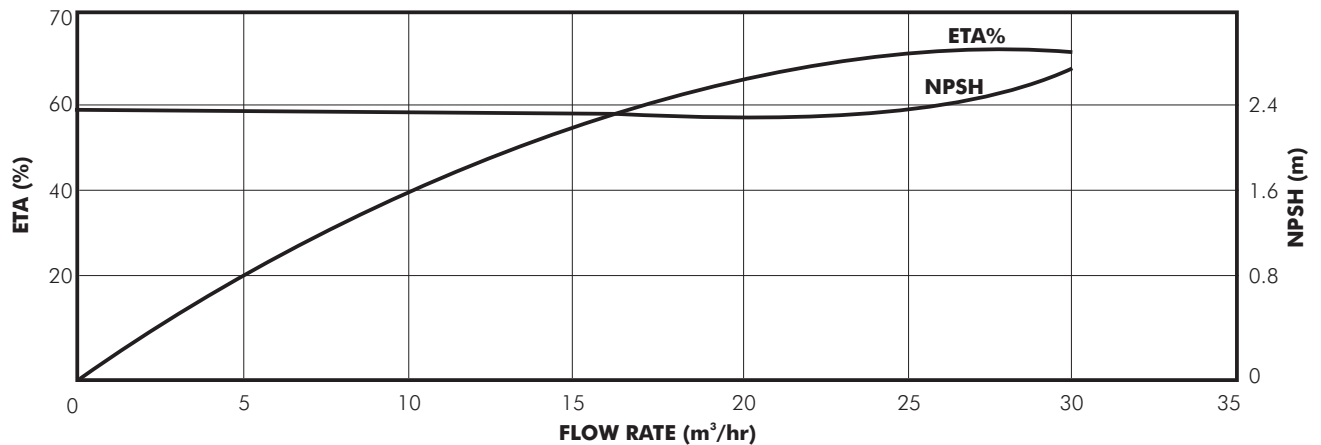
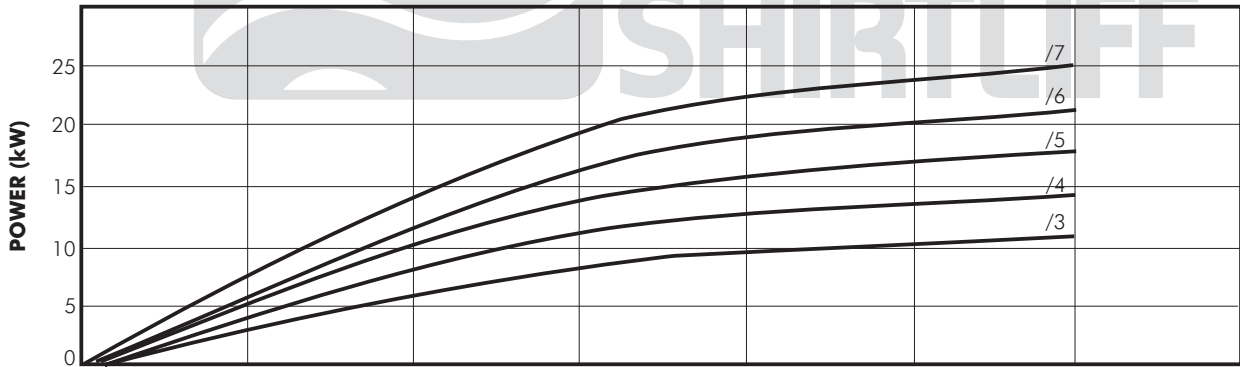
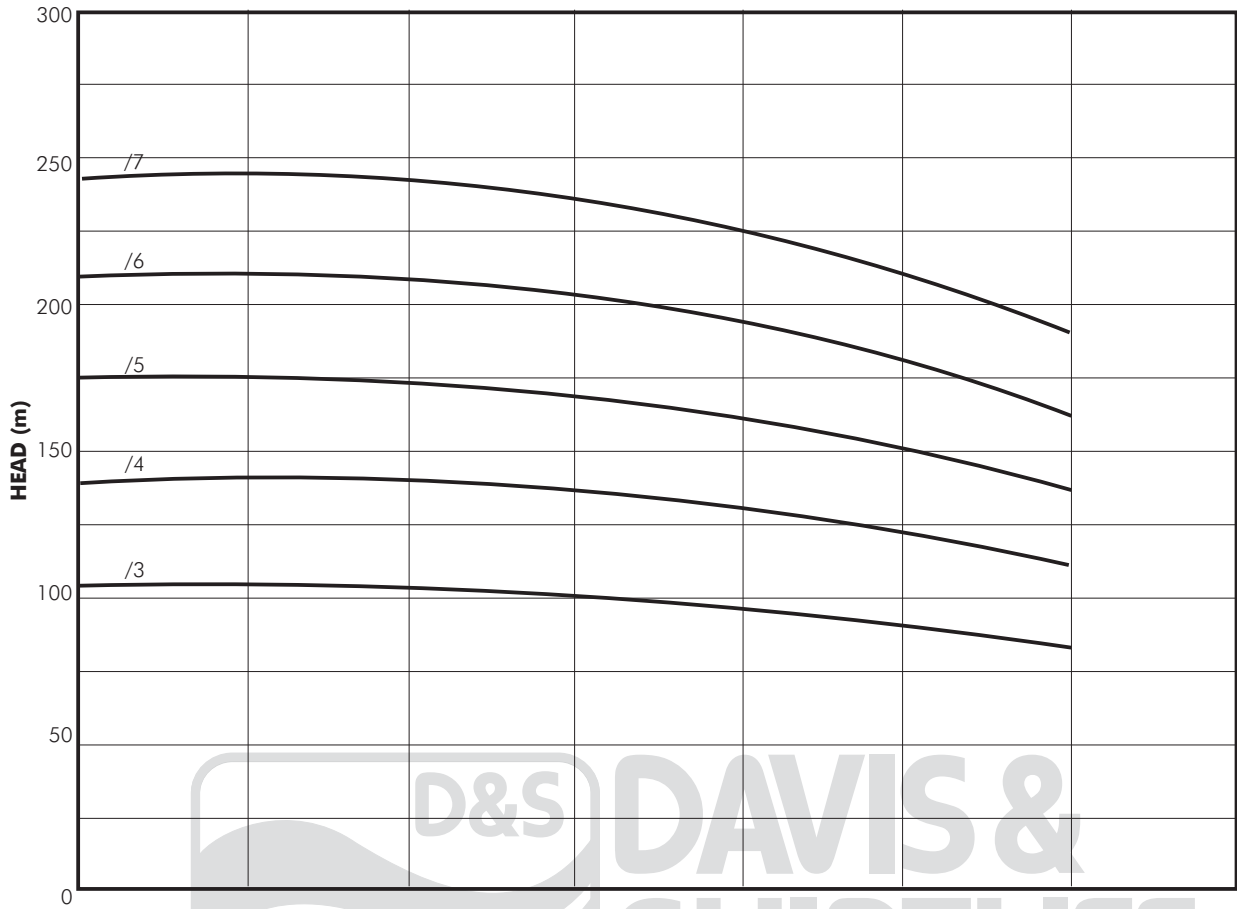



# DMS 46 PUMP CURVES 2950RPM

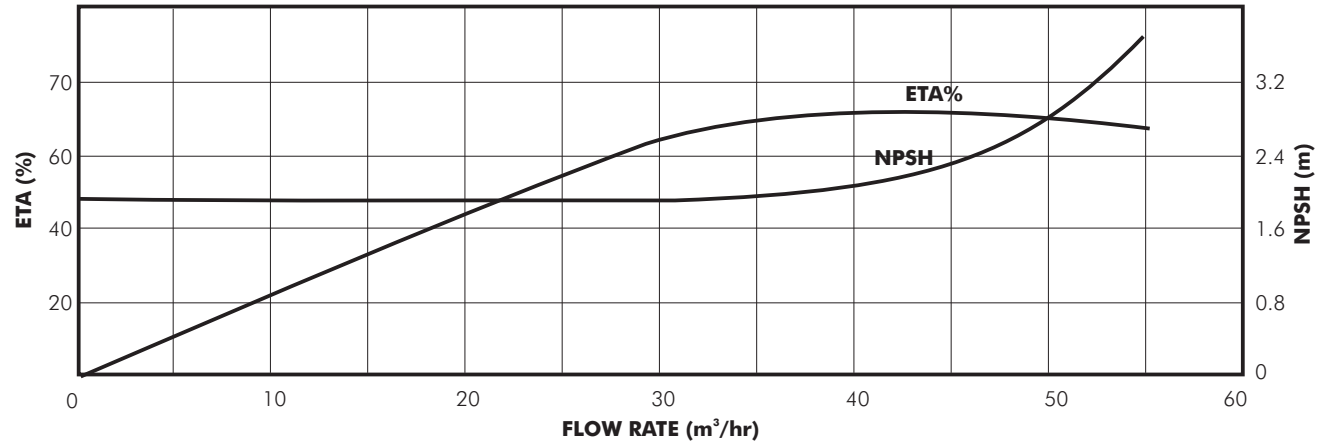
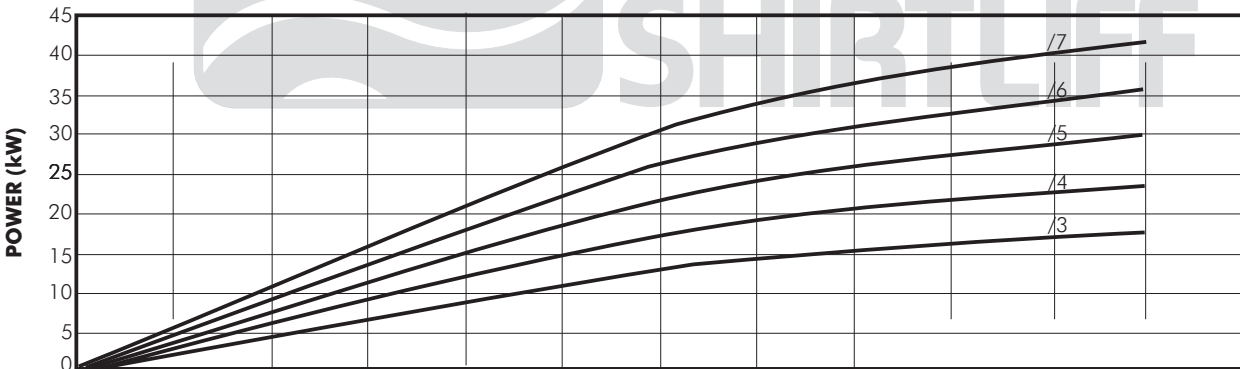
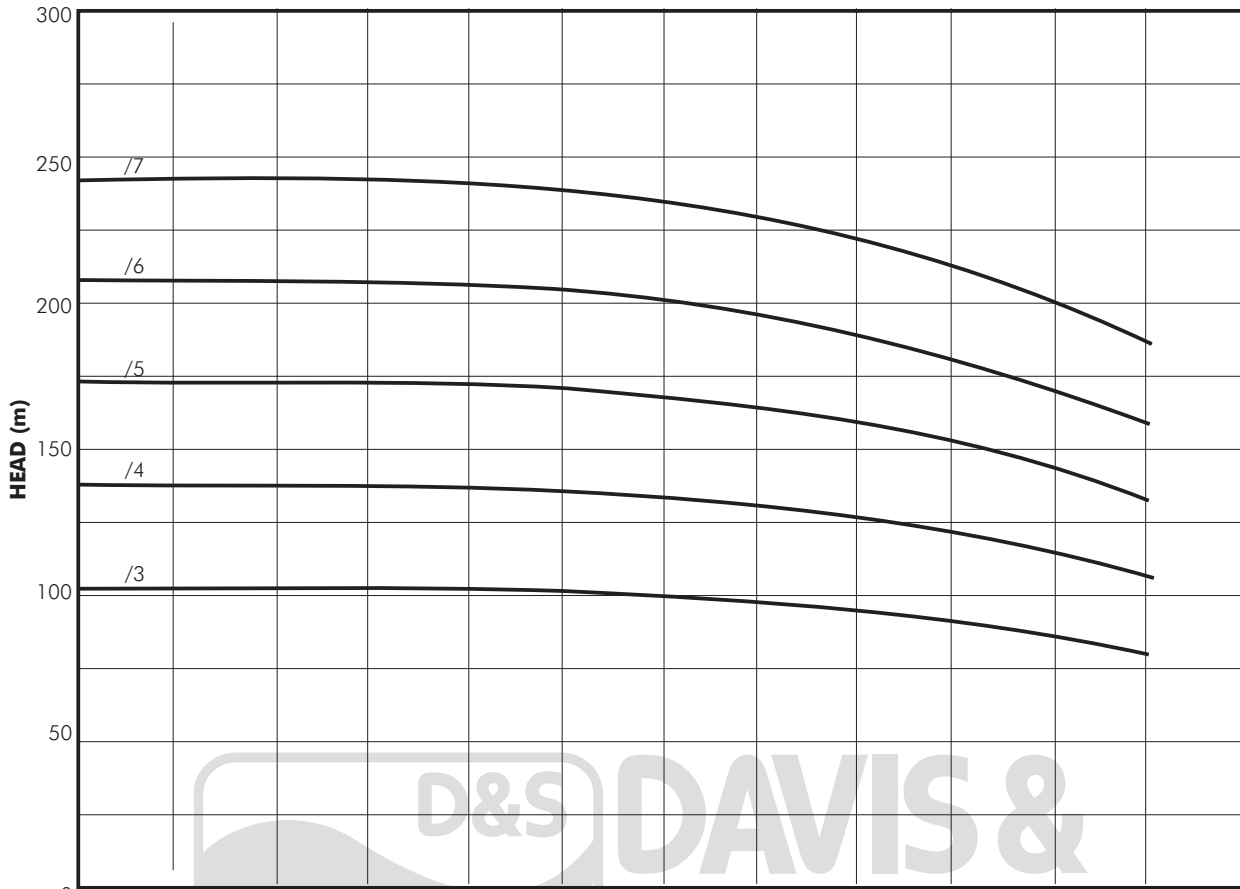

# DAYLIFF

## DMS 85 PUMP CURVES 2950RPM

